

Network Working Group
Request for Comments: 4165
Category: Standards Track

T. George
B. Bidulock
OpenSS7
R. Dantu
University of North Texas
H. Schwarzbauer
Siemens
K. Morneault
Cisco Systems
September 2005

Signaling System 7 (SS7) Message Transfer Part 2 (MTP2) -
User Peer-to-Peer Adaptation Layer (M2PA)

Status of This Memo

This document specifies an Internet standards track protocol for the Internet community, and requests discussion and suggestions for improvements. Please refer to the current edition of the "Internet Official Protocol Standards" (STD 1) for the standardization state and status of this protocol. Distribution of this memo is unlimited.

Copyright Notice

Copyright (C) The Internet Society (2005).

Abstract

This document defines a protocol supporting the transport of Signaling System Number 7 (SS7) Message Transfer Part (MTP) Level 3 signaling messages over Internet Protocol (IP) using the services of the Stream Control Transmission Protocol (SCTP). This protocol would be used between SS7 Signaling Points using the MTP Level 3 protocol. The SS7 Signaling Points may also use standard SS7 links using the SS7 MTP Level 2 to provide transport of MTP Level 3 signaling messages. The protocol operates in a manner similar to MTP Level 2 so as to provide peer-to-peer communication between SS7 endpoints.

Table of Contents

1. Introduction	3
1.1. Scope	3
1.2. Terminology	3
1.3. Abbreviations	4
1.4. Conventions	5
1.5. Signaling Transport Architecture	5
1.6. Services Provided by M2PA	7
1.7. Functions Provided by M2PA	9
1.8. Definition of the M2PA Boundaries	10
1.9. Differences Between M2PA and M2UA	10
2. Protocol Elements	12
2.1. Common Message Header	12
2.2. M2PA Header	13
2.3. M2PA Messages	14
3. State Control	17
3.1. SCTP Association State Control	17
3.2. M2PA Link State Control	18
4. Procedures	19
4.1. Procedures to Support MTP2 Features	19
4.2. Procedures to Support the MTP3/MTP2 Interface	30
4.3. SCTP Considerations	33
5. Examples of M2PA Procedures	34
5.1. Link Initialization (Alignment)	34
5.2. Message Transmission and Reception	37
5.3. Link Status Indication	37
5.4. Link Status Message (Processor Outage)	38
5.5. Level 2 Flow Control	42
5.6. MTP3 Signaling Link Congestion	44
5.7. Link Deactivation	45
5.8. Link Changeover	45
6. Security Considerations	47
7. IANA Considerations	47
7.1. SCTP Payload Protocol Identifier	47
7.2. M2PA Protocol Extensions	48
8. Acknowledgements	49
9. References	50
9.1. Normative References	50
9.2. Informative References	51

1. Introduction

1.1. Scope

There is a need for Switched Circuit Network (SCN) signaling protocol delivery over an IP network. This includes message transfer between the following:

- a Signaling Gateway (SG) and a Media Gateway Controller (MGC) [RFC2719]
- a SG and an IP Signaling Point (IPSP)
- an IPSP and an IPSP

This could allow for convergence of some signaling and data networks. SCN signaling nodes would have access to databases and other devices in the IP network domain that do not use SS7 signaling links. Likewise, IP telephony applications would have access to SS7 services. There may also be operational cost and performance advantages when traditional signaling links are replaced by IP network "connections".

The delivery mechanism described in this document allows for full MTP3 message handling and network management capabilities between any two SS7 nodes communicating over an IP network. An SS7 node equipped with an IP network connection is called an IP Signaling Point (IPSP). The IPSPs function as traditional SS7 nodes using the IP network instead of SS7 links.

The delivery mechanism should:

- Support seamless operation of MTP3 protocol peers over an IP network connection.
- Support the MTP Level 2 / MTP Level 3 interface boundary.
- Support management of SCTP transport associations and traffic instead of MTP2 Links.
- Support asynchronous reporting of status changes to management.

1.2. Terminology

MTP - The Message Transfer Part of the SS7 protocol [Q.700] [Q.701] [Q.702] [Q.703] [Q.704] [Q.705] [T1.111].

MTP2 - MTP Level 2, the MTP signaling link layer.

MTP3 - MTP Level 3, the MTP signaling network layer.

MTP2-User - A protocol that normally uses the services of MTP Level 2. The only MTP2 user is MTP3. The MTP2 user is equivalent to the M2PA user.

Signaling End Point (SEP) - An SS7 Signaling Point that originates or terminates signaling messages. One example is a central office switch. [RFC2719]

IP Signaling Point (IPSP) - An SS7 Signaling Point with an IP network connection used for SS7 over IP.

Signaling Gateway (SG) - A signaling agent that receives/sends SCN native signaling at the edge of the IP network [RFC2719]. In this context, an SG is an SS7 Signaling Point that has both an IP network connection used for SS7 over IP, and a traditional (non-IP) link to an SS7 network.

Signal Transfer Point (STP) - A Signal Transfer Point as defined by MTP standards, e.g., [Q.700].

Signaling Point (STP) - A Signaling Point as defined by MTP standards, e.g., [Q.700].

Association - An association refers to an SCTP association [RFC2960]. The association provides the transport for MTP3 protocol data units and M2PA adaptation layer peer messages.

Network Byte Order - Most significant byte first, also known as "Big Endian". See [RFC791], Appendix B "Data Transmission Order".

Stream - A stream refers to an SCTP stream [RFC2960].

1.3. Abbreviations

BSNT - Backward Sequence Number to be Transmitted

FSNC - Forward Sequence Number of last message accepted by remote level 2

LI - Length Indicator

MSU - Message Signal Unit

SCCP - Signaling Connection Control Part

SCN - Switched Circuit Network

SCTP - Stream Control Transmission Protocol

SIF - Signaling Information Field

SIO - Service Information Octet

SLC - Signaling Link Code

SS7 - Signaling System Number 7

SSN - Stream Sequence Number

STP - Signal Transfer Point

1.4. Conventions

The key words "MUST", "MUST NOT", "REQUIRED", "SHALL", "SHALL NOT", "SHOULD", "SHOULD NOT", "RECOMMENDED", "MAY", and "OPTIONAL" in this document are to be interpreted as described in [RFC2119].

1.5. Signaling Transport Architecture

The architecture that has been defined [RFC2719] for Switched Circuit Network (SCN) signaling transport over IP uses multiple components, including an IP transport protocol, the Stream Control Transmission Protocol (SCTP), and an adaptation module to support the services expected by a particular SCN signaling protocol from its underlying protocol layer.

Within this framework architecture, this document defines an SCN adaptation module that is suitable for the transport of SS7 MTP3 messages. The adaptation layer, known as the MTP2 User Peer-to-peer Adaptation Layer (M2PA), provides MTP3 with an interface and services similar to MTP2. In effect, MTP2 and lower layers of the traditional SS7 protocol stack are replaced by an IP equivalent.

Figure 1 shows the seamless interworking at the MTP3 layer. MTP3 is adapted to the SCTP layer using the MTP2 User Peer-to-peer Adaptation Layer (M2PA). All the primitives between MTP3 and MTP2 are supported by M2PA. The SCTP association acts as one SS7 link between the IPSPs. An IPSP may have the Signaling Connection Control Part (SCCP) and other SS7 layers above MTP3.

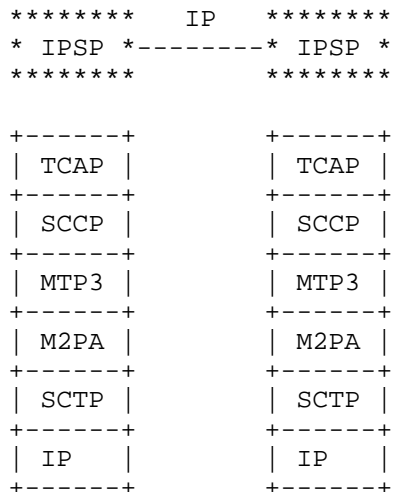

- IP - Internet Protocol
- IPSP - IP Signaling Point
- SCTP - Stream Control Transmission Protocol [RFC2960]

Figure 1. M2PA Symmetrical Peer-to-Peer Architecture

Figure 2 shows an example of M2PA used in a Signaling Gateway (SG). The SG is an IPSP that is equipped with both traditional SS7 and IP network connections.

The SEP and the SG communicate through a traditional SS7 link, which follows a protocol such as [Q.702]. The SG and the IPSP communicate through an IP link using the M2PA protocol. Messages sent from the SEP to the IPSP (and vice versa) are routed by the SG.

Any of the nodes in the diagram could have SCCP or other SS7 layers above MTP3. The Signaling Gateway acts as a Signal Transfer Point (STP). Other STPs MAY be present in the SS7 path between the SEP and the SG.

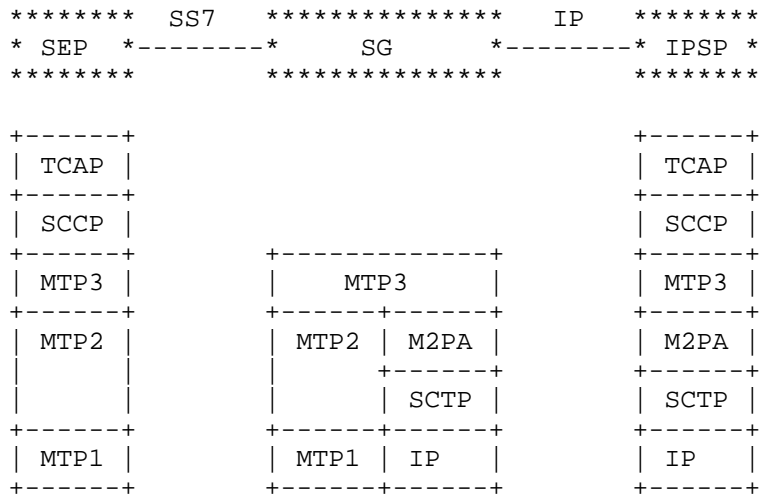

SEP - SS7 Signaling Endpoint

Figure 2. M2PA in IP Signaling Gateway

Figure 2 is only an example. Other configurations are possible. In short, M2PA uses the SCTP association as an SS7 link. The M2PA/SCTP/IP stack can be used in place of an MTP2/MTP1 stack.

1.5.1. Point Code Representation

MTP requires that each node with an MTP3 layer is identified by an SS7 point code. In particular, each IPSP MUST have its own SS7 point code.

1.6. Services Provided by M2PA

The SS7 MTP3/MTP2 (MTP2-User) interface is retained in the IPSP. The M2PA protocol layer is required to provide a set of services to its user equivalent to that provided by MTP Level 2 to MTP Level 3.

These services are described in the following subsections.

1.6.1. Support for MTP Level 2 / MTP Level 3 Interface Boundary

This interface is the same as the MTP2/MTP3 interface described in the applicable SS7 standards [Q.703] [Q.704] [T1.111] [Q.2140], with the addition of support for the larger sequence numbers found in [T1.111] and [Q.2210].

M2PA receives the primitives sent from MTP3 to its lower layer. M2PA processes these primitives or maps them to appropriate primitives at the M2PA/SCTP interface. Likewise, M2PA sends primitives to MTP3 similar to those used in the MTP3/MTP2 interface.

Because M2PA uses larger sequence numbers than MTP2, the MTP3 Changeover procedure MUST use the Extended Changeover Order and Extended Changeover Acknowledgement messages described in [Q.2210] and [T1.111].

Also, the following MTP3/MTP2 primitives must use the larger sequence numbers:

- BSNT Confirmation
- Retrieval Request and FSNC

1.6.2. Support for Peer-to-Peer Communication

In SS7, MTP Level 2 sends three types of messages, known as signal units: Message Signal Units (MSUs), Link Status Signal Units (LSSUs), and Fill-In Signal Units (FISUs).

MSUs originate at a higher level than MTP2, and are destined for a peer at another node. Likewise, M2PA passes these messages from MTP3 to SCTP as data for transport across a link. These are called User Data messages in M2PA.

LSSUs allow peer MTP2 layers to exchange status information. Analogous messages are needed for M2PA. The Link Status message serves this purpose.

FISUs are transmitted continuously when no other signal units are waiting to be sent. FISUs also carry acknowledgement of messages. Since an IP network is a shared resource, it would be undesirable to have a message type that is sent continuously as is the case with FISUs. Furthermore, SCTP does not require its upper layer to continuously transmit messages. Therefore, M2PA does not provide a protocol data unit like the FISU. The M2PA User Data message is used to carry acknowledgement of messages. If M2PA needs to acknowledge a message, and it has no MTP3 message of its own to send, an empty User Data message can be sent.

1.7. Functions Provided by M2PA

1.7.1. MTP2 Functionality

M2PA provides MTP2 functionality that is not provided by SCTP; thus, together M2PA and SCTP provide functionality similar to that of MTP2.

SCTP provides reliable, sequenced delivery of messages.

M2PA functionality includes:

- Data retrieval to support the MTP3 changeover procedure
- Reporting of link status changes to MTP3
- Processor outage procedure
- Link alignment procedure

1.7.2. Mapping of SS7 and IP Entities

The M2PA layer must maintain a map of each of its SS7 links to the corresponding SCTP association.

1.7.3. SCTP Association Management

SCTP allows a user-specified number of streams to be opened during the initialization. It is the responsibility of the M2PA layer to ensure proper management of the streams allowed within each association.

M2PA uses two streams in each direction for each association. Stream 0 in each direction is designated for Link Status messages. Stream 1 is designated for User Data messages, as well as Link Status messages that must remain in sequence with the User Data messages. Separating the Link Status and User Data messages into separate streams allows M2PA to prioritize the messages in a manner similar to MTP2.

Notifications received from SCTP are processed by M2PA or translated into an appropriate notification to be sent to the upper layer MTP3.

1.7.4. Retention of MTP3 in the SS7 Network

M2PA allows MTP3 to perform all of its Message Handling and Network Management functions with IPSPs as it does with other SS7 nodes.

1.8. Definition of the M2PA Boundaries

1.8.1. Definition of the M2PA / MTP Level 3 Boundary

The upper layer primitives provided by M2PA are the same as those provided by MTP2 to MTP3. These primitives are described in the applicable SS7 standards [Q.703] [Q.704] [T1.111] [Q.2140].

1.8.2. Definition of the Lower Layer Boundary between M2PA and SCTP

The upper layer primitives provided by SCTP are described in [RFC2960] Section 10 "Interface with Upper Layer".

1.9. Differences Between M2PA and M2UA

The MTP2 User Adaptation Layer (M2UA) [M2UA] also adapts the MTP3 layer to the SCTP/IP stack. It does so through a backhauling architecture [RFC2719]. This section is intended to clarify some of the differences between the M2PA and M2UA approaches.

A possible M2PA architecture is shown in Figure 3. Here the IPSP's MTP3 uses its underlying M2PA as a replacement for MTP2. Communication between the two layers MTP3/M2PA is defined by the same primitives as in SS7 MTP3/MTP2. M2PA performs functions similar to MTP2.

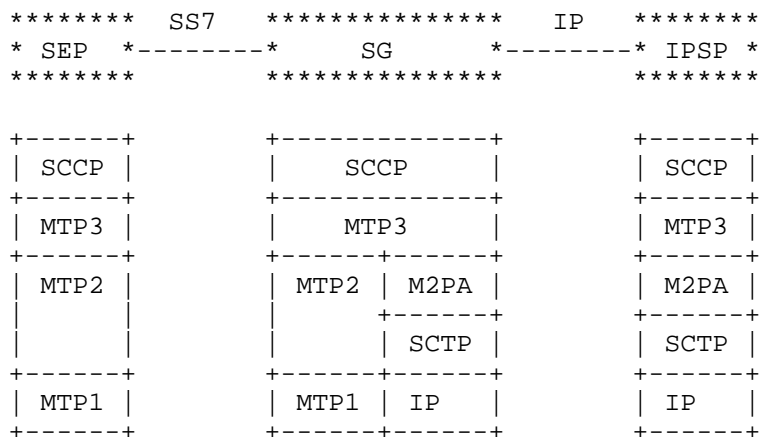
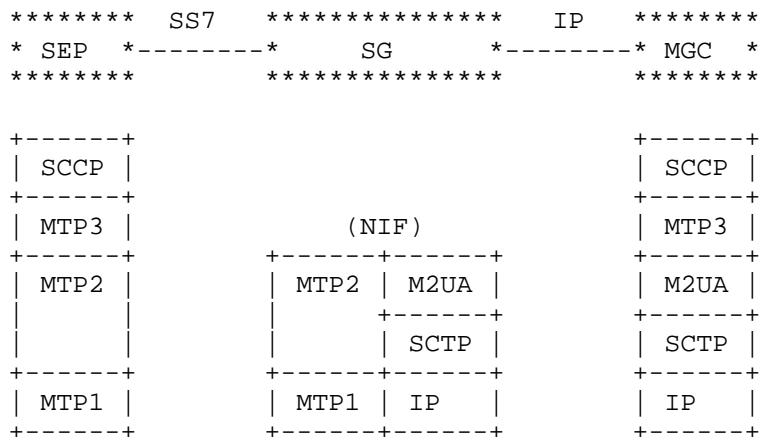

Figure 3. M2PA in IP Signaling Gateway

A comparable architecture for M2UA is shown in Figure 4. In M2UA, the MGC's MTP3 uses the SG's MTP2 as its lower SS7 layer. Likewise, the SG's MTP2 uses the MGC's MTP3 as its upper SS7 layer. In SS7,

communication between the MTP3 and MTP2 layers is defined by primitives. In M2UA, the MTP3/MTP2 communication is defined as M2UA messages and sent over the IP connection.



NIF - Nodal Interworking Function

Figure 4. M2UA in IP Signaling Gateway

M2PA and M2UA are similar in that:

- a. Both transport MTP3 data messages.
- b. Both present an MTP2 upper interface to MTP3.

Differences between M2PA and M2UA include:

- a. M2PA: IPSP processes MTP3/MTP2 primitives.
M2UA: MGC transports MTP3/MTP2 primitives between the SG's MTP2 and the MGC's MTP3 (via the NIF) for processing.
- b. M2PA: SG-IPSP connection is an SS7 link.
M2UA: SG-MGC connection is not an SS7 link. It is an extension of MTP to a remote entity.
- c. M2PA: SG is an SS7 node with a point code.
M2UA: SG is not an SS7 node and has no point code.
- d. M2PA: SG can have upper SS7 layers, e.g., SCCP.
M2UA: SG does not have upper SS7 layers since it has no MTP3.
- e. M2PA: relies on MTP3 for management procedures.
M2UA: uses M2UA management procedures.

Potential users of M2PA and M2UA should be aware of these differences when deciding how to use them for SS7 signaling transport over IP networks.

2. Protocol Elements

This section describes the format of various messages used in this protocol.

All fields in an M2PA message must be transmitted in the network byte order, i.e., most significant byte first, unless otherwise stated.

2.1. Common Message Header

The protocol messages for M2PA require a message header structure that contains a version, message class, message type, and message length. The header structure is shown in Figure 5.

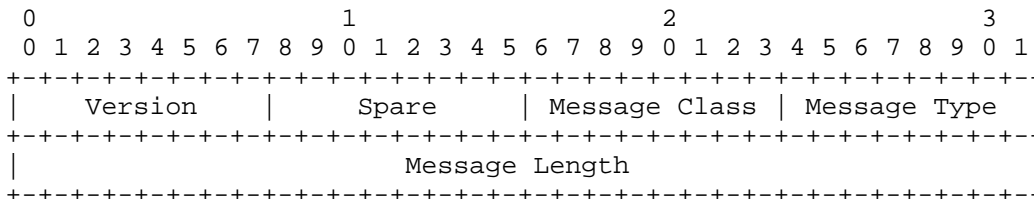

Figure 5. Common Message Header

2.1.1. Version

The version field contains the version of M2PA. The supported versions are:

Value (decimal)	Version
1	Release 1.0 of M2PA protocol

2.1.2. Spare

The Spare field SHOULD be set to all zeroes (0's) by the sender and ignored by the receiver. The Spare field SHOULD NOT be used for proprietary information.

2.1.3. Message Class

The following List contains the valid Message Classes:

Value (decimal)	Message Class
11	M2PA Messages

Other values are invalid for M2PA.

2.1.4. Message Type

The following list contains the message types for the defined messages.

Value (decimal)	Message Type
1	User Data
2	Link Status

Other values are invalid.

2.1.5. Message Length

The Message Length defines the length of the message in octets, including the Common Header.

2.2. M2PA Header

All protocol messages for M2PA require an M2PA-specific header. The header structure is shown in Figure 6.

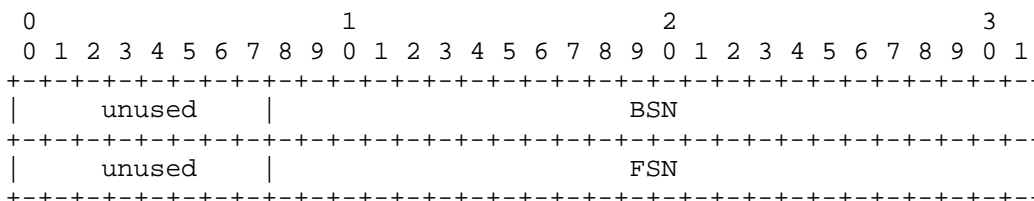

Figure 6. M2PA-specific Message Header

2.2.1. Backward Sequence Number (BSN)

This is the FSN of the message last received from the peer.

2.2.2. Forward Sequence Number (FSN)

This is the M2PA sequence number of the User Data message being sent.

The FSN and BSN values range from 0 to 16,777,215.

2.3. M2PA Messages

The following section defines the messages and parameter contents. An M2PA message consists of a Common Message Header and M2PA Header, followed by the data appropriate to the message.

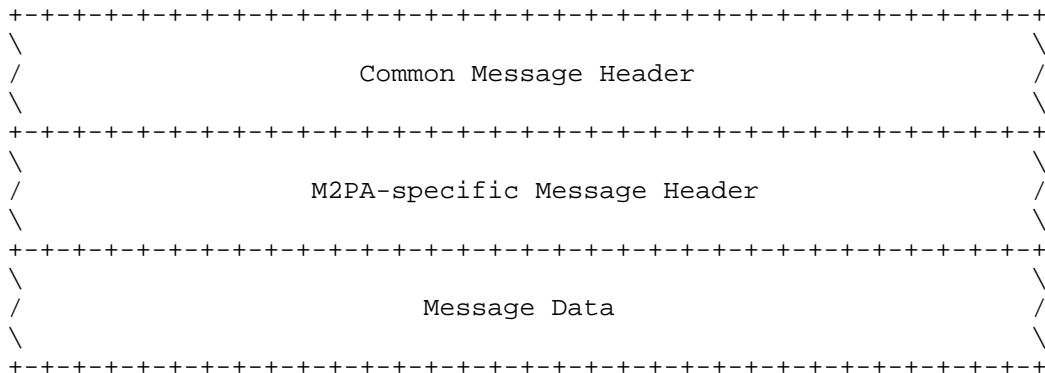

The field "Message Data" contains either:

- a User Data message (Section 2.3.1), or
- a Link State message (Section 2.3.2)

2.3.1. User Data

The User Data is the data sent from MTP3. The User Data is an optional field. It need not be included in an acknowledgement-only message.

The format of the User Data message is as follows:

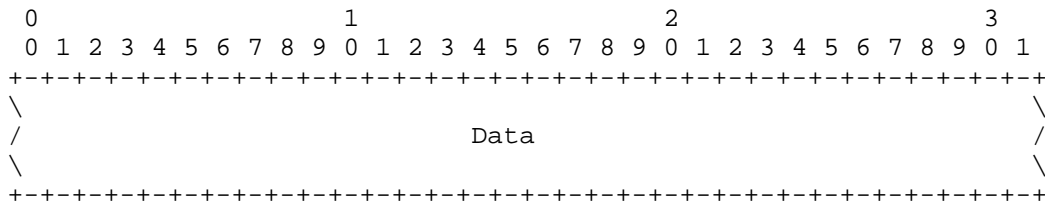

The Data field contains the following fields of the MTP Message Signal Unit (MSU):

- the Message Priority field (PRI)
- Service Information Octet (SIO)
- Signaling Information Field (SIF)

The MTP MSU is described in Q.703 [Q.703], Section 2.2, "Signal Unit Format", and T1.111.3 [T1.111], Section 2.2, "Signal Unit Format". The Japanese TTC standard uses the PRI field as an MTP3 Message Priority field [JT-Q703] [JT-Q704]. For versions of MTP that do not use these two bits, the entire first octet of the Data field is spare.

The format of the first octet of the Data field is:

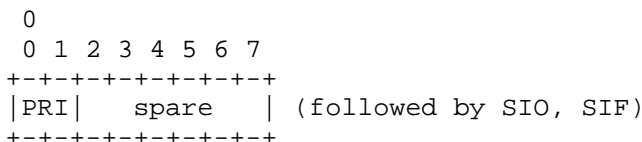

PRI - Priority used only in national MTP defined in [JT-Q703] and [JT-Q704]. These bits are spare for other MTP versions.

Note that the Data field SHALL NOT contain other components of the MTP MSU format:

- Flag
- Backward Sequence Number (BSN)
- Backward Indicator Bit (BIB)
- Forward Sequence Number (FSN)
- Forward Indicator Bit (FIB)
- Length Indicator (LI)
- Check bits (CK)

The Data field SHALL be transmitted in the byte order as defined by MTP3.

M2PA SHALL NOT add padding to the MTP3 message.

Note: In the SS7 Recommendations, the format of the messages and fields within the messages are based on bit transmission order. In these recommendations, the Least Significant Bit (LSB) of each field is positioned to the right. The received SS7 fields are populated octet by octet as received into the 4-octet word, as shown below.

As an example, in the ANSI MTP protocol, the Data field format is shown below:

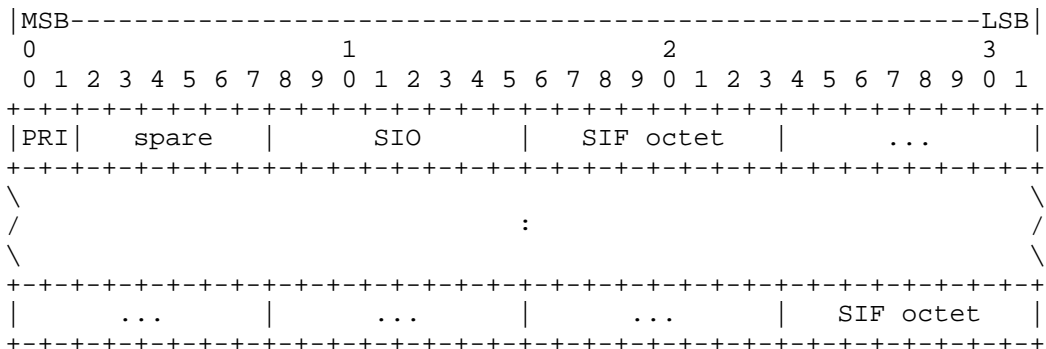

Within each octet, the Least Significant Bit (LSB) per the SS7 Recommendations is to the right (e.g., bit 15 of SIO is the LSB).

2.3.2. Link Status

The MTP2 Link Status message can be sent between M2PA peers to indicate link status. This message performs a function similar to the Link Status Signal Unit in MTP2. The format of the Link Status message is as follows:

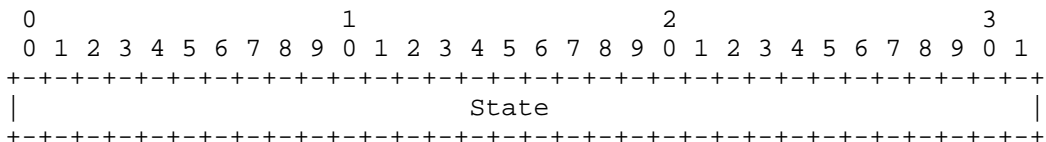

The valid values for State are shown in the following table.

Value (decimal)	Description
1	Alignment
2	Proving Normal
3	Proving Emergency
4	Ready
5	Processor Outage
6	Processor Recovered
7	Busy
8	Busy Ended
9	Out of Service (OOS)

2.3.2.1. Link Status Proving

The Link Status Proving message may optionally carry additional bytes. If the optional bytes are used, the format of the message is as follows.

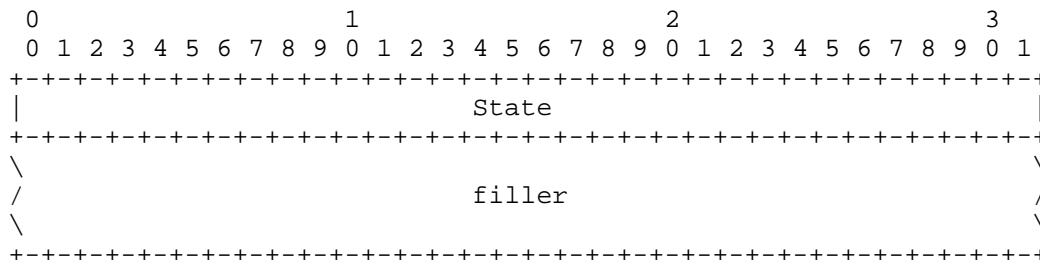

It is RECOMMENDED that the length of the Link Status Proving message be similar to the size of the User Data messages that will be carried on the link.

It is RECOMMENDED that the filler field contain a number pattern that varies among the Link Status Proving messages, and that allows the SCTP checksum [RFC3309] to be used to verify the accuracy of transmission.

3. State Control

3.1. SCTP Association State Control

Figure 7 illustrates state changes in the M2PA management of the SCTP association, together with the causing events. Note that some of the error conditions are not shown in the state diagram.

Following is a list of the M2PA Association States and a description of each.

IDLE - State of the association during power-up initialization.

ASSOCIATING - M2PA is attempting to establish an SCTP association.

ESTABLISHED - SCTP association is established.

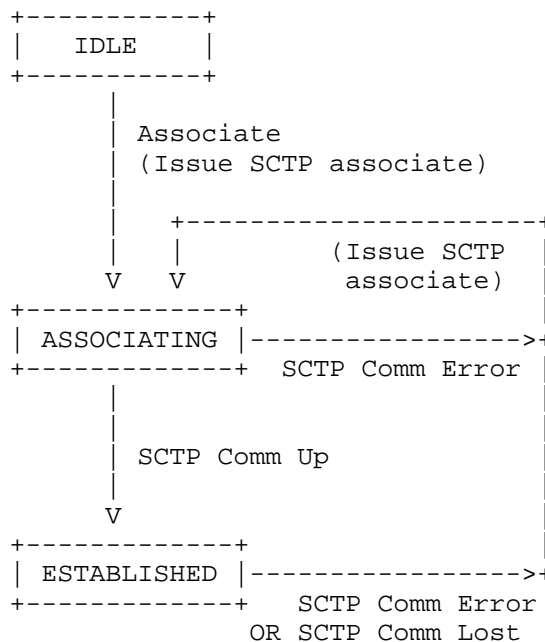

Figure 7. M2PA Association State Transition Diagram

3.2. M2PA Link State Control

The M2PA link moves from one state to another in response to various events. The events that may result in a change of state include:

- MTP3 primitive requests
- Receipt of messages from the peer M2PA
- Expiration of timers
- SCTP notifications

These events affect the M2PA link state in a manner similar to MTP2.

4. Procedures

Because M2PA provides MTP3 with an interface and functionality like MTP2, its internal functioning is similar to that of MTP2.

Except as modified in this document, M2PA SHOULD follow the requirements of the applicable MTP2 specification. These may include [Q.703] or [T1.111]. The same standard MUST be followed on both ends of the M2PA link.

In particular, the corresponding applicable timer value defaults and ranges specified for the applicable MTP2 standard should be used for the M2PA timers.

When referring to MTP2 terminology in this document, the terminology of [Q.703] is used. This does not imply that the requirements of [Q.703] are to be followed.

4.1. Procedures to Support MTP2 Features

4.1.1. Signal Unit Format, Delimitation, Acceptance

Messages for transmission across the network must follow the format described in Section 2.

SCTP provides reliable, in-sequence delivery of user messages. Therefore the related functionality of MTP2 is not needed. SCTP does not provide functions related to Link State Control in MTP2. These functions must be provided by M2PA.

Since SCTP provides delivery of messages, there is no need for M2PA to delimit its messages with a flag, as is done in MTP2. Furthermore, M2PA does not need to perform zero bit insertion and deletion on its messages.

Since SCTP uses a checksum to detect transmission errors, there is no need for an M2PA checksum, as is needed in MTP2. This also eliminates the need for the error rate monitors of MTP2.

Since SCTP provides reliable delivery and ordered delivery, M2PA does not perform retransmissions. This eliminates the need for the forward and backward indicator bits in MTP2 signal units.

Acceptance of a message is indicated by a successful receipt of the message from SCTP.

4.1.2. MTP and SCTP Entities

This section describes how M2PA relates MTP and SCTP entities.

Each MTP link corresponds to an SCTP association. To prevent duplicate associations from being established, it is RECOMMENDED that each endpoint know the IP address (or IP addresses, if multi-homing is used) and port number of both endpoints. SCTP prevents two associations with the same IP addresses and port numbers from being established.

It is necessary for at least one of the endpoints to be listening on the port on which the other endpoint is trying to establish the association. Therefore, at least one of the port numbers SHOULD be the M2PA registered port.

If only one association is to be established between these two IP addresses, then the association SHOULD be established using the M2PA registered port at each endpoint.

If it is desirable to create multiple associations (for multiple links) between the two IP addresses, different port numbers can be used for each association. Nevertheless, the M2PA registered port number SHOULD be used at one end of each association.

Each combination of IP address/port for the two endpoints (i.e., each association) MUST be mapped to the same Signaling Link Code (SLC) at each endpoint, so that each endpoint knows which link is being created at the time the SCTP association is established. However, M2PA does not do any processing based on the SLC.

Following are examples of the relationships between associations and links. Note that a link is an SCTP association identified by two endpoints. Each endpoint is identified by an IP address and port number. Each association is mapped to an SLC.

Figure 8 shows a case with two IPSPs, each with two IP addresses. Two associations are the links that connect the two IPSPs. Since these links are in the same link set, they MUST have different SLCs.

Table 1 shows the relationships in tabular form. Table 1 is only conceptual. The actual method for mapping the SCTP associations to the SLCs is implementation dependent.

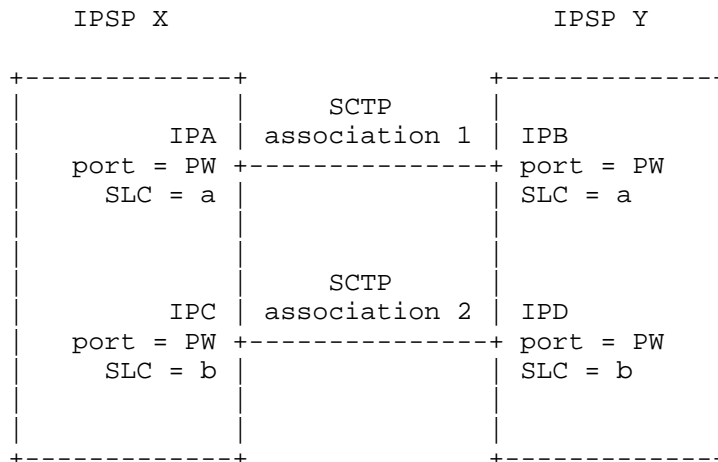

IPx = IP address
 PW = Registered port number for M2PA

Figure 8. Two IPSPs with Two IP Addresses Each

Association	IPSP X		IPSP Y		SLC
	IP address	Port	IP address	Port	
1	IPA	PW	IPB	PW	a
2	IPC	PW	IPD	PW	b

Table 1. Two IPSPs with Two IP Addresses Each

Figure 9 and Table 2 show an example with three IPSPs. Note that in this example, the two links are in different link sets. Therefore, it is possible that the SLC values a and b MAY be equal.

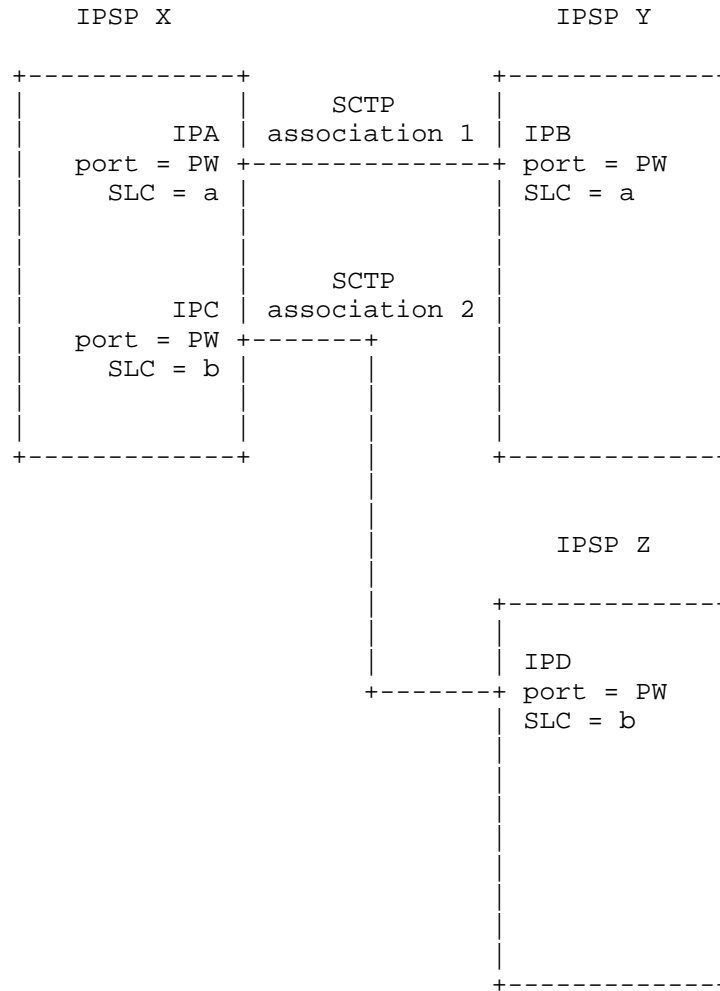

IPx = IP address
 PW = Registered port number for M2PA

Figure 9. One IPSP Connected to Two IPSPs

Association	IPSP X		IPSP Y/Z		SLC
	IP address	Port	IP address	Port	
1	IPA	PW	IPB	PW	a
2	IPC	PW	IPD	PW	b

Table 2. One IPSP Connected to Two IPSPs

Figure 10 and Table 3 show two associations between the same IP addresses. This is accomplished by using different port numbers for each association at one endpoint.

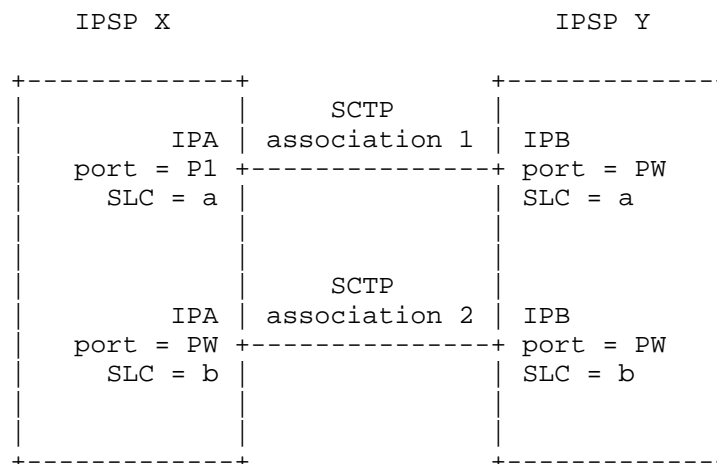

IPx = IP address

P1 = Pre-selected port number

PW = Registered port number for M2PA

Figure 10. Multiple Associations Between Two IP Addresses

Association	IPSP X		IPSP Y		SLC
	IP address	Port	IP address	Port	
1	IPA	P1	IPB	PW	a
2	IPA	PW	IPB	PW	b

Table 3. Multiple Associations Between Two IP Addresses

The association SHALL contain two streams in each direction. Stream 0 is designated for Link Status messages. Stream 1 is designated for User Data messages, as well as Link Status messages that must remain in sequence with the User Data messages.

The following Link Status messages SHALL be sent on the Link Status stream (stream 0):

- Alignment
- Proving Normal
- Proving Emergency
- Ready (when sent during alignment)
- Busy
- Busy Ended
- Out of Service

The following Link Status messages SHALL be sent on the User Data stream (stream 1):

- Processor Outage
- Processor Recovered
- Ready (when sent at the end of processor outage)

4.1.3. Link Alignment

The purposes of the alignment procedure are:

- (1) To provide a handshaking procedure so that both endpoints are prepared to send SS7 traffic, and to prevent traffic from being sent before the other end is ready.
- (2) To verify that the SCTP association is suitable for use as an SS7 link.

Link alignment takes place after the association is established. If SCTP fails to establish the association, and M2PA has received a Start Request from its MTP3, then M2PA SHALL report to MTP3 that the link is out of service.

The Link Status Out of Service message replaces the SIOS message of MTP2. Unlike MTP2, the message SHOULD NOT be transmitted continuously. After the association is established, M2PA SHALL send a Link Status Out of Service message to its peer. Prior to the beginning of alignment, M2PA MAY send additional Link Status Out of Service messages.

The Link Status Alignment message replaces the SIO message of MTP2. This message is sent to signal the beginning of the alignment procedure. The Link Status Alignment message SHOULD NOT be transmitted continuously. M2PA MAY send additional Link Status Alignment until it receives Link Status Alignment, Link Status Proving Normal, or Link Status Proving Emergency from the peer.

The Link Status Proving Normal message replaces the SIN message of MTP2. The Link Status Proving Emergency message replaces the SIE message of MTP2.

The proving period MAY be omitted if this is allowed by the applicable MTP2 standard (e.g., [Q.2140]).

If proving is performed, then during the proving period (i.e., after M2PA starts the proving period timer T4), M2PA SHALL send Link Status Proving messages to its peer at an interval defined by the protocol parameter Proving_Interval. It is RECOMMENDED that Proving_Interval be set so that the traffic load generated with the Link Status Proving messages during the proving period is comparable to the normal traffic load expected when the link is in service.

The Link Status Ready message replaces the FISU of MTP2 that is sent at the end of the proving period. The Link Status Ready message is used to verify that both ends have completed proving. When M2PA starts timer T1, it SHALL send a Link Status Ready message to its peer in the case where MTP2 would send a FISU after proving is complete. If the Link Status Ready message is sent, then M2PA MAY send additional Link Status Ready messages while timer T1 is running. These Link Status Ready messages are sent on the Link Status stream.

In the case that MTP2 sends an MSU or SIPO message at the end of proving, M2PA SHALL send (respectively) a User Data or Link Status Processor Outage message.

4.1.4. Processor Outage

The Link Status Processor Outage message replaces the SIPO message of MTP2. Unlike MTP2, the message SHOULD NOT be transmitted continuously. M2PA SHALL send a Link Status Processor Outage message to its peer at the beginning of a processor outage condition where MTP2 would send SIPO. M2PA MAY send additional Link Status Processor Outage messages as long as that condition persists. The Link Status Processor Outage message SHALL be sent on the User Data stream.

While in a local processor outage (LPO) condition:

- (a) Any User Data messages received from the peer MUST NOT be acknowledged and MUST be buffered.
- (b) M2PA SHOULD continue to acknowledge User Data messages received and accepted by MTP3 before the local processor outage.
- (c) M2PA SHOULD continue to transmit messages that have been sent by its upper layer MTP3.

While there is a remote processor outage (RPO) condition:

- (a) M2PA SHOULD continue to acknowledge User Data messages received and accepted by MTP3, regardless of the remote processor outage.
- (b) If any User Data messages received from the peer after the Link Status Processor Outage cannot be delivered to MTP3, then these messages MUST NOT be acknowledged and MUST be buffered.

If M2PA receives a Flush command from MTP3,

- (a) M2PA SHALL discard any incoming messages that were queued and unacknowledged during the processor outage condition.
- (b) M2PA SHALL discard messages in the transmit and retransmit queues as required by MTP2.

If M2PA receives a Continue command from MTP3, M2PA SHALL begin processing the incoming messages that were queued and unacknowledged during the processor outage condition.

When the local processor outage condition ends, M2PA SHALL send a Link Status Processor Recovered message to its peer on the User Data stream. This message is used to signal the end of the processor outage condition, instead of an MSU or FISU, as is used in MTP2. The

BSN in the Link Status Processor Recovered message is set to the FSN of the last User Data message received (and not discarded) from the peer M2PA. M2PA SHALL cease transmitting User Data messages after sending the Link Status Processor Recovered message, until it has received the Link Status Ready message (see below).

Upon receiving the Link Status Processor Recovered message, the M2PA in RPO SHALL respond with a Link Status Ready message on the User Data stream. The BSN in the Link Status Ready message is set to the FSN of the last User Data message received (and not discarded) from the peer M2PA.

Upon receiving the Link Status Ready message, the M2PA formerly in LPO SHALL respond with a Link Status Ready message on the User Data stream. The BSN in the Link Status Ready message is set to the FSN of the last User Data message received (and not discarded) from the peer M2PA.

M2PA (at both the LPO and RPO ends) uses the BSN value in the received Link Status Ready message to resynchronize its sequence numbers, if this is required by MTP2. M2PA SHALL NOT resume transmitting User Data messages until it has sent the Link Status Ready message.

During resynchronization, M2PA SHALL NOT discard any received User Data messages that were sent after the processor outage ended.

When M2PA experiences a local processor outage, it MAY put the link out of service by sending a Link Status Out of Service message, if this is allowed by the applicable MTP2 standard (e.g., [Q.2140]).

In other respects, M2PA SHOULD follow the same procedures as MTP2 in processor outage.

4.1.5. Level 2 Flow Control

The Link Status Busy message replaces the SIB message of MTP2. The message SHOULD NOT be transmitted continuously. M2PA SHALL send a Link Status Busy message to its peer at the beginning of a receive congestion condition where MTP2 would send SIB. M2PA MAY send additional Link Status Busy messages as long as that condition persists. When the condition ends, M2PA SHALL send a Link Status Busy Ended message to its peer.

M2PA SHALL continue transmitting messages while it is in receive congestion, but MUST NOT acknowledge the message that triggered the sending of the Link Status Busy message, nor any messages received before the sending of Link Status Busy Ended.

When the peer M2PA receives the first Link Status Busy message, it SHALL start the Remote Congestion timer T6 if there are messages in the retransmission buffer awaiting acknowledgement (i.e., T7 is running). M2PA SHALL stop the T7 timer if it is running. Additional Link Status Busy messages received while T6 is running do not cause T6 to be reset and do not cause T7 to be started. While T6 is running, T7 SHALL NOT be started.

When the peer M2PA receives the Link Status Busy Ended message and T6 has not expired, it SHALL stop T6 (if T6 is running) and start T7 (if there are messages awaiting acknowledgement in the retransmission buffer).

The peer M2PA SHOULD continue receiving and acknowledging messages while the other end is busy, but MUST NOT send User Data messages after receiving Link Status Busy and before receiving Link Status Busy Ended.

4.1.6. Link Out of Service

The Link Status Out of Service message replaces the SIOS message of MTP2. Unlike MTP2, the message SHOULD NOT be transmitted continuously. M2PA SHALL send a Link Status Out of Service message to its peer at the beginning of a condition where MTP2 would send SIOS. M2PA MAY send additional Link Status Out of Service messages as long as that condition persists.

When M2PA places a link in the OUT OF SERVICE state, M2PA SHOULD NOT terminate the SCTP association.

4.1.7. SCTP Association Problems

The SCTP association for a link may become unusable, such as when one of the following occurs:

- SCTP sends a Send Failure notification to M2PA.
- SCTP sends a Communication Lost notification to M2PA.
- SCTP sends a Communication Error notification to M2PA.
- The SCTP association is lost.

If the SCTP association for a link becomes unable to transmit or receive messages, M2PA SHALL report to MTP3 that the link is out of service and enter the OUT OF SERVICE state.

4.1.8. Transmission and Reception Priorities

In MTP, Link Status messages have priority over User Data messages ([Q.703], Section 11.2). To achieve this in M2PA, M2PA uses separate streams in its SCTP association for Link Status messages and User Data messages.

M2PA SHALL send all messages using the ordered delivery option of SCTP.

M2PA SHOULD give higher priority to messages sent on the Link Status stream than to messages sent on the User Data stream when sending messages to SCTP.

M2PA SHOULD give higher priority to reading the Link Status stream than to reading the User Data stream.

M2PA SHOULD give higher priority to receiving notifications from SCTP than to reading either the Link Status stream or the User Data stream.

4.1.9. M2PA Version Control

A node upgraded to a newer version of M2PA SHOULD support the older versions used on other nodes with which it is communicating. If that is the case, then alignment can proceed normally.

In particular, it is recommended that for future modifications to this protocol:

- Any newer version SHOULD be able to process the messages from an older version.
- A newer version of M2PA SHOULD refrain from sending messages to an older version of M2PA messages that the older version cannot process.
- If an older version of M2PA receives a message that it cannot process, it SHOULD discard the message.
- In cases where different processing is done in two versions for the same format of a message, then the newer version SHOULD contain procedures to recognize and handle this appropriately.

In case a newer version of M2PA is incompatible with an older version, the newer version SHOULD recognize this and prevent the alignment of the link. If a Link Status Alignment message with an

unsupported version is received by the newer version, the receiving end's M2PA SHOULD reply with a Link Status Out of Service message and not complete the alignment procedure.

4.2. Procedures to Support the MTP3/MTP2 Interface

4.2.1. Sending and Receiving Messages

When MTP3 sends a message for transmission to M2PA, M2PA passes the corresponding M2PA message to SCTP using the SEND primitive.

User Data messages SHALL be sent via the User Data stream (stream 1) of the association.

M2PA Link Status messages are passed to SCTP using the SEND primitive.

The following Link Status messages SHALL be sent on the Link Status stream (stream 0):

- Alignment
- Proving Normal
- Proving Emergency
- Ready (when sent during alignment)
- Busy
- Busy Ended
- Out of Service

The following Link Status messages SHALL be sent on the User Data stream (stream 1):

- Processor Outage
- Processor Recovered
- Ready (when sent at the end of processor outage)

If M2PA receives a message from SCTP with an invalid Message Class or unsupported Message Type in the Common Message Header, M2PA SHALL discard the message.

For message types other than User Data, the Forward Sequence Number is set to the FSN of the last User Data message sent.

If M2PA receives a User Data message with an FSN that is out of order, M2PA SHALL discard the message.

Note: In all calculations involving FSN and BSN, the programmer should be aware that the value wraps around to 0 after reaching its maximum value.

When there is a message to acknowledge, M2PA MUST acknowledge the message with the next User Data message sent. If there is no User Data message available to be sent when there is a message to acknowledge, M2PA SHOULD generate and send a User Data message with no data payload, without delay. (In other words, in the case where MTP2 would acknowledge a message with a FISU, M2PA SHOULD acknowledge the message with an empty User Data message.) The FSN for this empty User Data message is not incremented. It MUST contain the same FSN as the most recently sent User Data message that contains data. Delaying of acknowledgements can result in poor SS7 performance.

If M2PA receives an empty User Data message, it SHALL NOT send an acknowledgement of that message.

Note that there is no reason to place Link Status messages or empty User Data messages in the M2PA retransmit buffer, since these messages are not retrieved for changeover and timer T7 does not apply to them.

Note that since SCTP provides reliable delivery and ordered delivery within the stream, M2PA does not perform retransmissions. Nevertheless, M2PA SHALL retain transmitted User Data messages in a retransmit queue until they are acknowledged. These messages are needed in case MTP3 performs data retrieval as part of a changeover procedure.

Because propagation delays in IP networks are more variable than in traditional SS7 networks, a single T7 timer (excessive delay of acknowledgement), as in MTP2, is inadequate. If any message is unacknowledged after a period equal to the T7 value, the T7 timer SHALL expire.

4.2.2. MTP3 Signaling Link Congestion

M2PA SHALL detect transmit congestion in its buffers according to the requirements for signaling link transmit congestion in MTP3, e.g., Q.704 [Q.704], Section 3.8.

4.2.3. Changeover

The objective of the changeover is to ensure that signaling traffic carried by the unavailable signaling link is diverted to the alternative signaling link(s) as quickly as possible while avoiding message loss, duplication, or mis-sequencing. For this purpose, the changeover procedure includes data retrieval, which is performed before opening the alternative signaling links to the diverted traffic. Data retrieval consists of these steps:

- (1) buffer updating, i.e., identifying all those User Data messages in the retransmission buffer of the unavailable signaling link which have not been received by the far end M2PA, as well as untransmitted messages, and
- (2) transferring those messages to the transmission buffers of the alternate links.

Note that only User Data messages containing data are retrieved and transmitted over the alternate links. Link Status messages and empty User Data messages SHALL NOT be retrieved and transmitted over the alternate links.

M2PA's Sequence Numbers are 24 bits long. MTP2's Forward and Backward Sequence Numbers are only seven bits long. Hence, it is necessary for MTP3 to accommodate the larger sequence numbers. This is done through the use of the Extended Changeover Order (XCO) and Extended Changeover Acknowledgement (XCA) messages instead of the Changeover Order (COO) and Changeover Acknowledgement (COA) messages. The XCO and XCA messages are specified in [Q.2210] Section 9.8.1 and T1.111.4 [T1.111], Section 15.4. Only the XCO and XCA messages from [Q.2210] or [T1.111] are required. The BSN is placed in the XCO/XCA message as explained in [Q.2210] and [T1.111].

Also, the following MTP3/MTP2 primitives MUST use the larger sequence numbers:

- BSNT Confirmation
- Retrieval Request and FSNC

If M2PA receives a Retrieval Request and FSNC request from MTP3, M2PA SHALL retrieve from its buffers and deliver to MTP3 in order:

- (a) any transmitted User Data messages beginning with the first unacknowledged message with FSN greater than FSNC.
- (b) any untransmitted User Data messages.

For emergency changeover, MTP3 retrieves only the unsent messages for transmission on the alternate link(s). If M2PA receives a Retrieval Request and FSNC request with no FSNC value, or with an invalid FSNC, then M2PA SHALL retrieve from its buffers and deliver to MTP3 in order:

- (a) any untransmitted User Data messages.

The Japanese TTC version of MTP defined in [JT-Q703] and [JT-Q704] has a Retrieval Request (as well as Retrieval Request and FSNC). The Retrieval allows MTP3 to retrieve both unsent and unacknowledged messages for transmission on the alternate link(s). In this version of MTP, if M2PA receives a Retrieval Request, then M2PA SHALL retrieve from its buffers and deliver to MTP3 in order:

- (a) any transmitted but unacknowledged User Data messages.
- (b) any untransmitted User Data messages.

4.2.3.1. Multiple User Data Streams and Changeover

The changeover procedure makes it problematic for M2PA to have multiple User Data streams in one direction for a link. Buffer updating would have to be done separately for each User Data stream to avoid duplication or loss of messages. But MTP3 provides for only one XCO/XCA message for sending the last-received sequence number.

Even with sequence numbering of User Data messages at the M2PA layer, it is necessary to perform buffer updating on each stream. Since the M2PA messages would be delivered over multiple streams, there could be a gap in the M2PA sequence numbers at the receiving end when the changeover procedure begins. If only the M2PA sequence number is used in the XCO/XCA message, there would be a possibility of losing the messages in the gap, or duplicating messages after the gap.

M2PA links with multiple User Data streams would be possible if a multiple-BSNT XCO/XCA message is defined in MTP3, or if MTP3 allows multiple XCO/XCA messages (one for each User Data stream) to be sent during a changeover. This is beyond the scope of this document.

4.3. SCTP Considerations

Some M2PA procedures may be affected by the use of SCTP as a transport layer. These considerations are discussed in this section.

4.3.1. SCTP Slow Start

SCTP contains a slow start algorithm to control the amount of data being injected into the network. The algorithm allows SCTP to probe the network to determine the available capacity. The algorithm is invoked in these cases: when transmission begins on an association, after a sufficiently long idle period, or after repairing loss detected by the SCTP retransmission timer.

It is possible that transmission of M2PA messages MAY be delayed by SCTP slow start under certain conditions, including the following:

- (a) Link Alignment. Link alignment takes place after an association is established. SCTP invokes the slow start algorithm since transmission is beginning on the association.
- (b) Changeover. Messages are retrieved from one link (association) and transferred to another for transmission. If the second link had previously been idle, or is in the process of link alignment, SCTP may invoke the slow start algorithm.
- (c) Path failure (multi-homing). If SCTP switches from a failed path to a new path, and the new path had previously been idle, SCTP may invoke the slow start algorithm.
- (d) Reduced traffic volume. Any time that M2PA sends a low volume of traffic on a link and then the volume increases, SCTP may invoke the slow start algorithm.

Programmers should be aware of this condition and how it may affect M2PA performance. In some cases, it may be possible to avoid the negative effects of slow start. For example, the Link Status Proving messages sent during the proving period may be used to complete slow start before the link is placed in service.

5. Examples of M2PA Procedures

In general, messages passed between MTP3 and M2PA are the same as those passed between MTP3 and MTP2. M2PA interprets messages from MTP3 and sends the appropriate message to SCTP. Likewise, messages from SCTP are used to generate a meaningful message to MTP3.

Note that throughout this section, the primitives between MTP3 and M2PA are named using the MTP terminology [Q.700] [Q.701] [Q.702] [Q.703] [Q.704] [Q.705]. Communications between M2PA and SCTP are named using SCTP terminology.

5.1. Link Initialization (Alignment)

An example of the message flow used to bring an SS7 link in service is shown in Figures 11 and 12. Alignment is done by both ends of the link. To simplify the diagram, alignment is shown on one end only. Some messages from the remote end are not shown. It is assumed in this example that SCTP has been initialized.

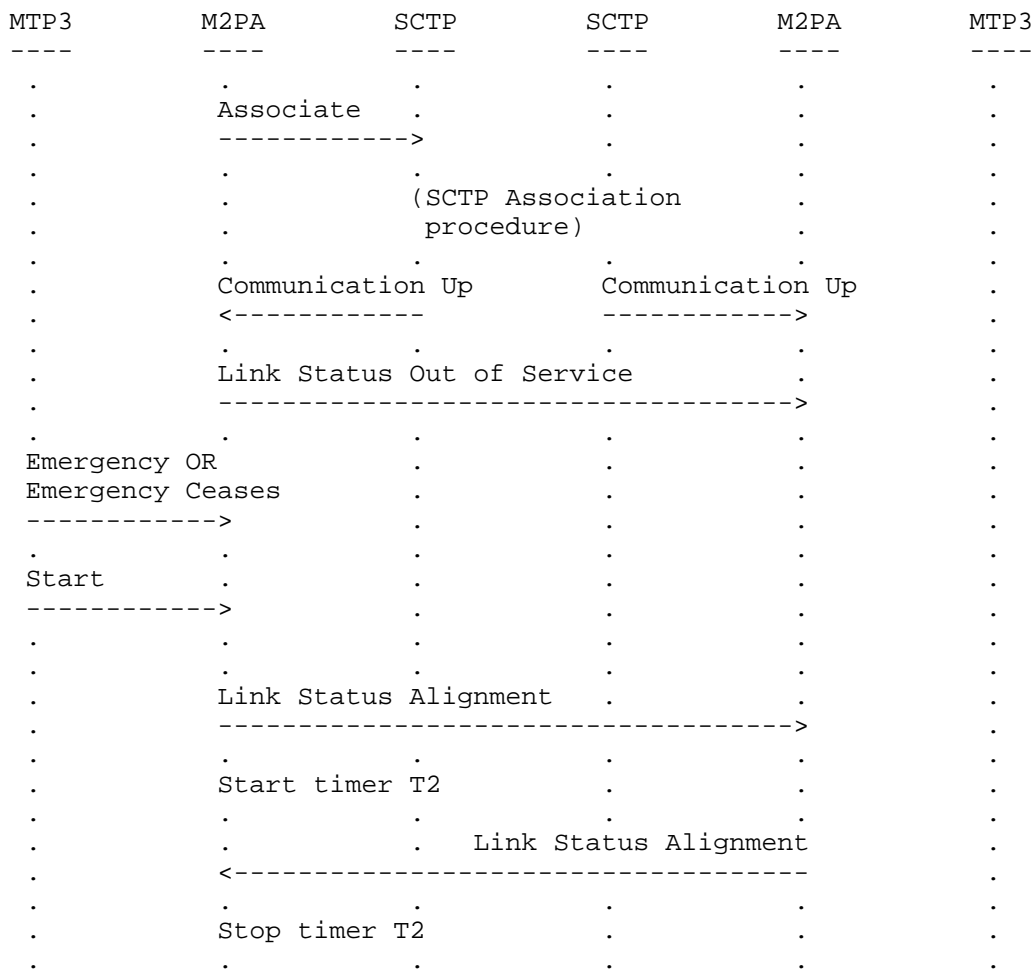

Proving period begins.

Figure 11. Example: Link Initialization - Alignment

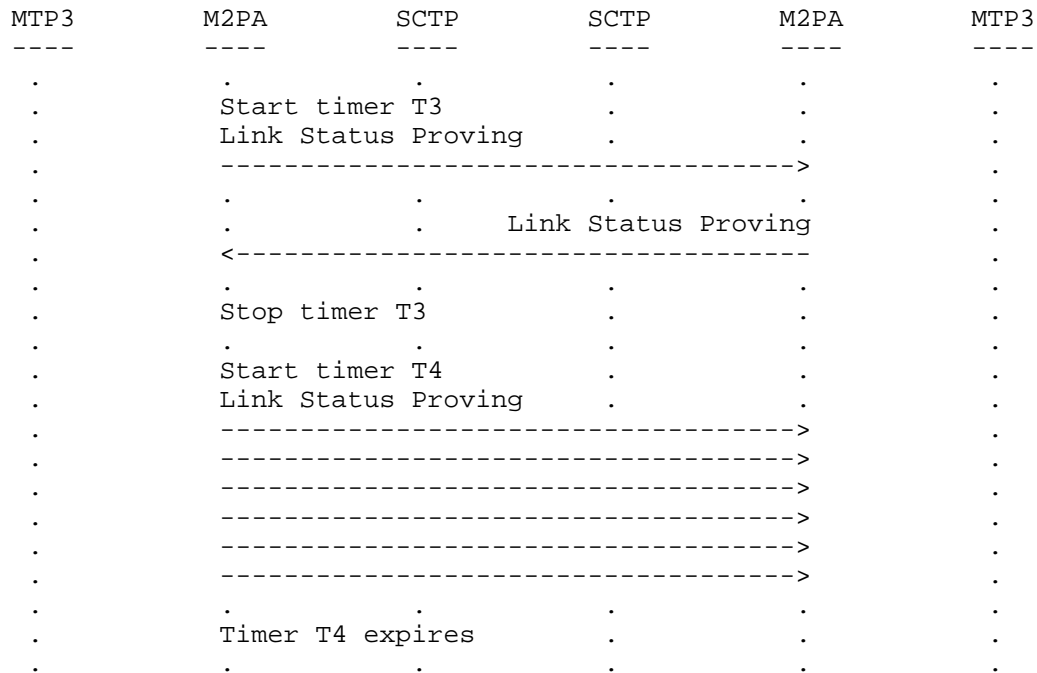

Send Link Status Ready (one or more) and wait for the remote end to complete its proving period.

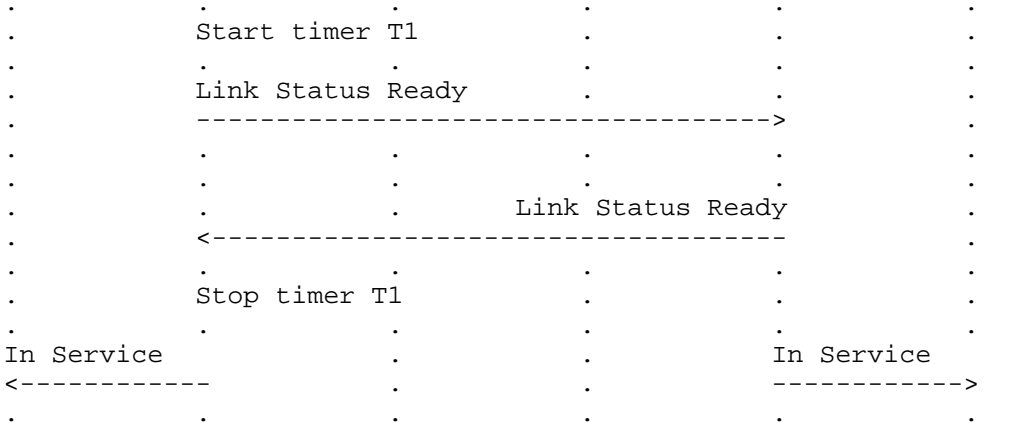

MTP3 MAY begin sending data messages.

Figure 12. Example: Link Initialization - Proving

5.2. Message Transmission and Reception

Messages are transmitted using the Data Request primitive from MTP3 to M2PA. Figure 13 shows the case where the Link is In Service. The message is passed from MTP3 of the source to MTP3 of the destination.

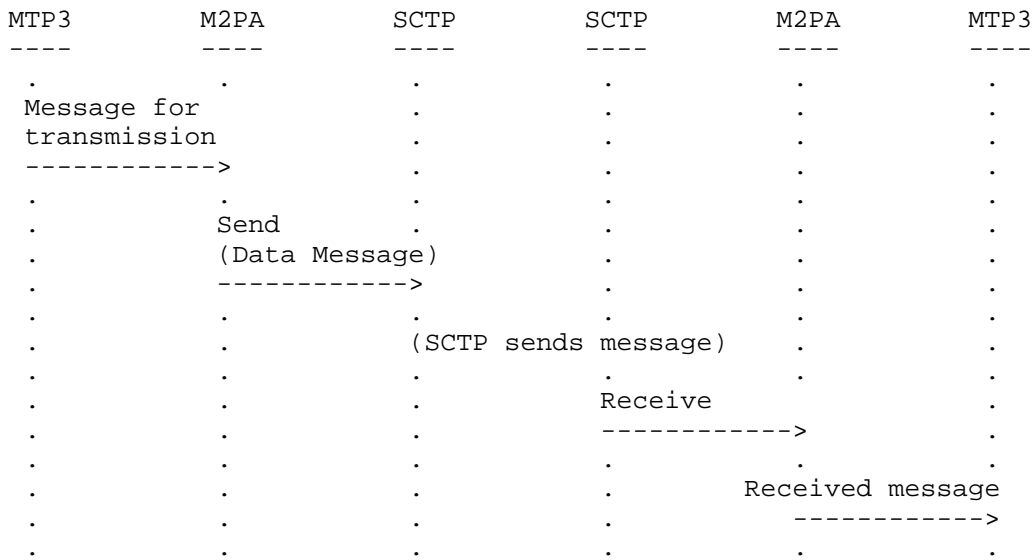

Figure 13. Example: Link Initialization - In Service

5.3. Link Status Indication

An example of a Link Status Indication is shown in Figure 14. If SCTP sends a Communication Lost primitive to M2PA, M2PA notifies MTP3 that the link is out of service. MTP3 responds in its usual way.

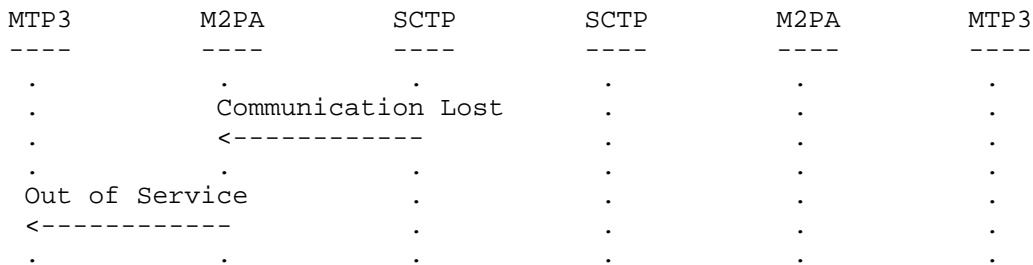

Figure 14. Example: Link Status Indication

5.4. Link Status Message (Processor Outage)

Figure 15 shows how M2PA responds to a local processor outage. M2PA sends a Link Status message to its peer. The peer M2PA notifies MTP3 of the outage. MTP3 can then follow the processor outage procedures as in [Q.703].

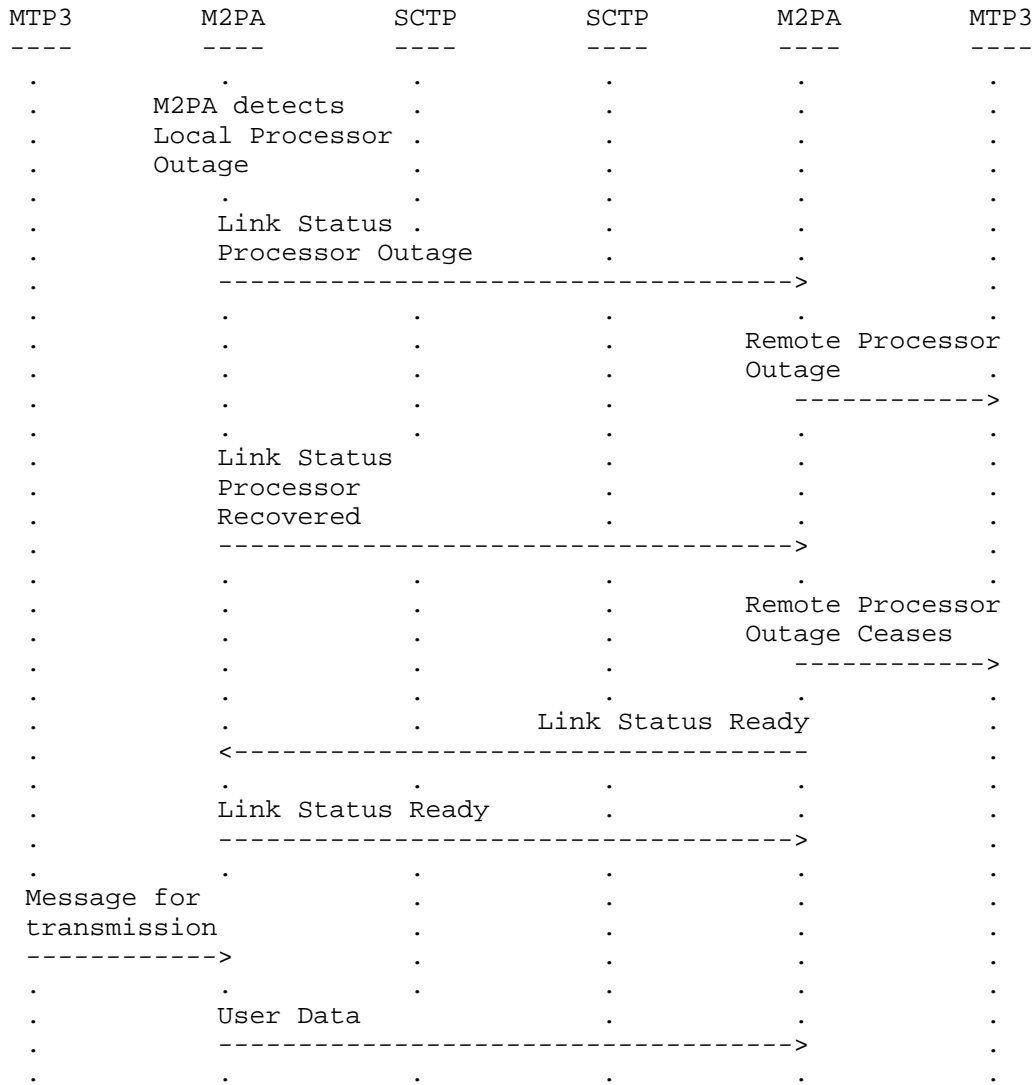
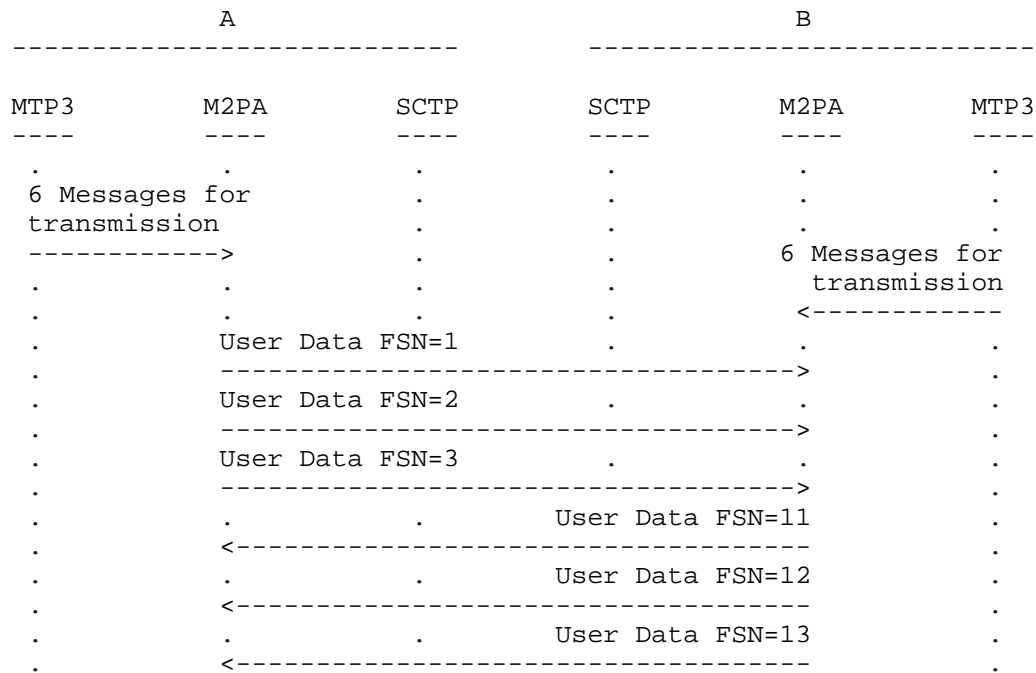
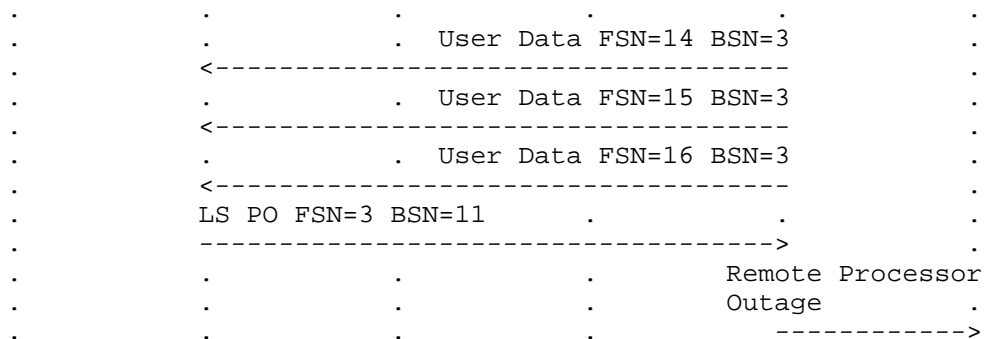

Figure 15. Example: Link Status Message - Processor Outage

Figure 16 shows an example of processor outage in more detail. All M2PA messages in this example are sent on the Data stream (stream 1).



Side A detects LPO.



While in LPO, A must buffer messages 14-16 without acknowledging them. A may continue transmitting messages from MTP3, and acknowledging messages that were received before LPO.

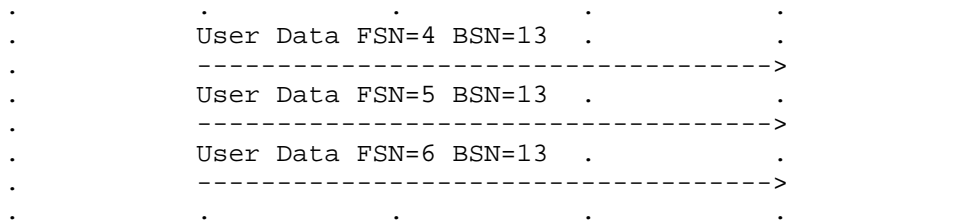

While in RPO, B may continue acknowledging messages. Suppose that B receives message 4 and 5, but has not processed 6 yet.

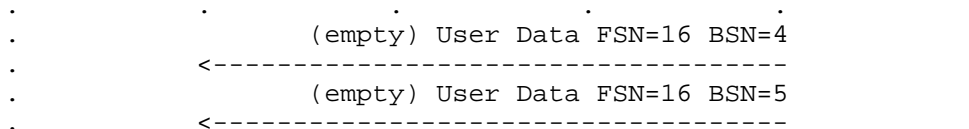

LPO ends at A. A flushes 14-16 (the messages that were buffered without acknowledgement).

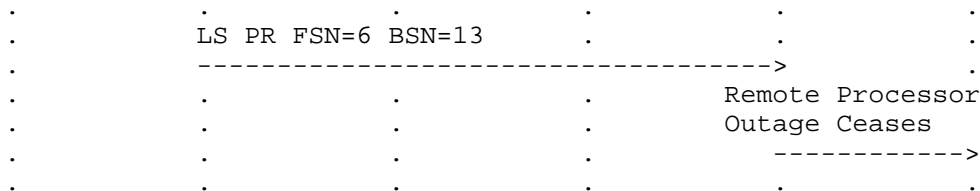

Suppose that B processed message 5, but never processed message 6. B flushes message 6 from its Receive Buffer. B notifies A of this using the Link Status Ready message setting BSN=5, the last message that was processed at B.

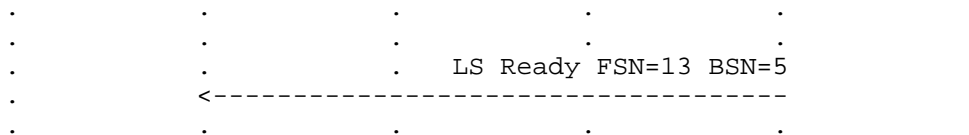

B has completed synchronization of sequence numbers and has sent an LS Ready, so it is able to resume sending data at this point with the new sequence numbers (starting with FSN=14).

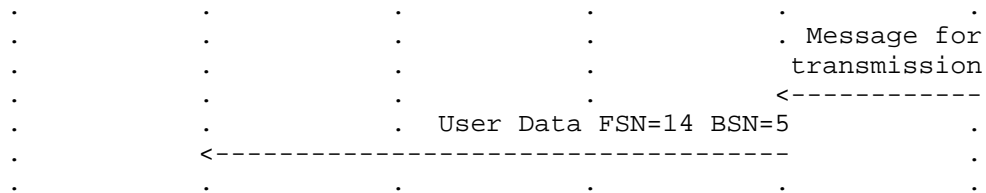

A can use the Link Status Ready information to resynchronize its sequence numbers to begin with FSN=6 in the next User Data message.

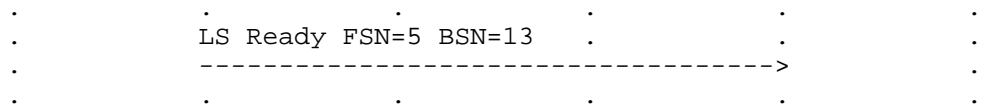

A has completed synchronization of sequence number and has both received and sent an LS Ready, so it is able to resume sending data at this point with the new sequence numbers and acknowledging data received after receiving LS Ready.

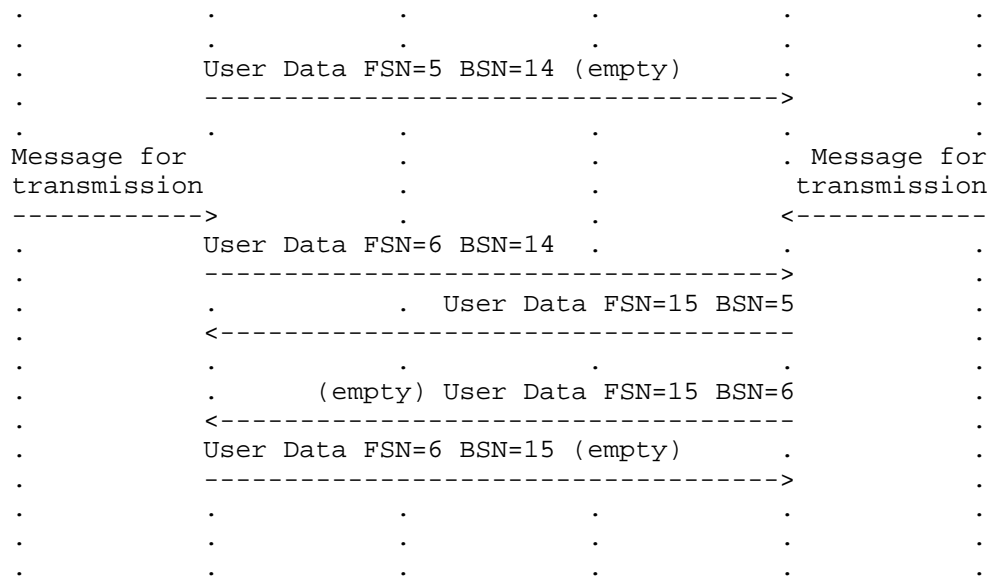

Figure 16. Example: Processor Outage and Recovery

5.5. Level 2 Flow Control

Figures 17 and 18 illustrate the Level 2 Flow Control procedure. In Figure 17, congestion ceases before timer T6 expires. Figure 18 shows the case where T6 expires.

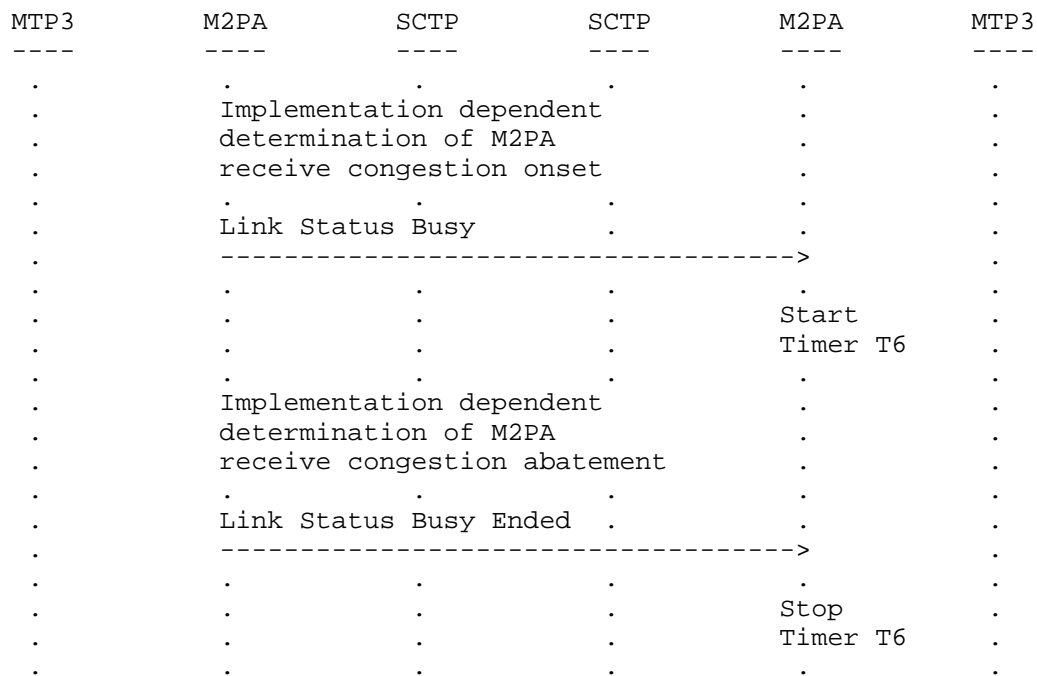

Figure 17. Example: Level 2 Flow Control - Congestion Ceases

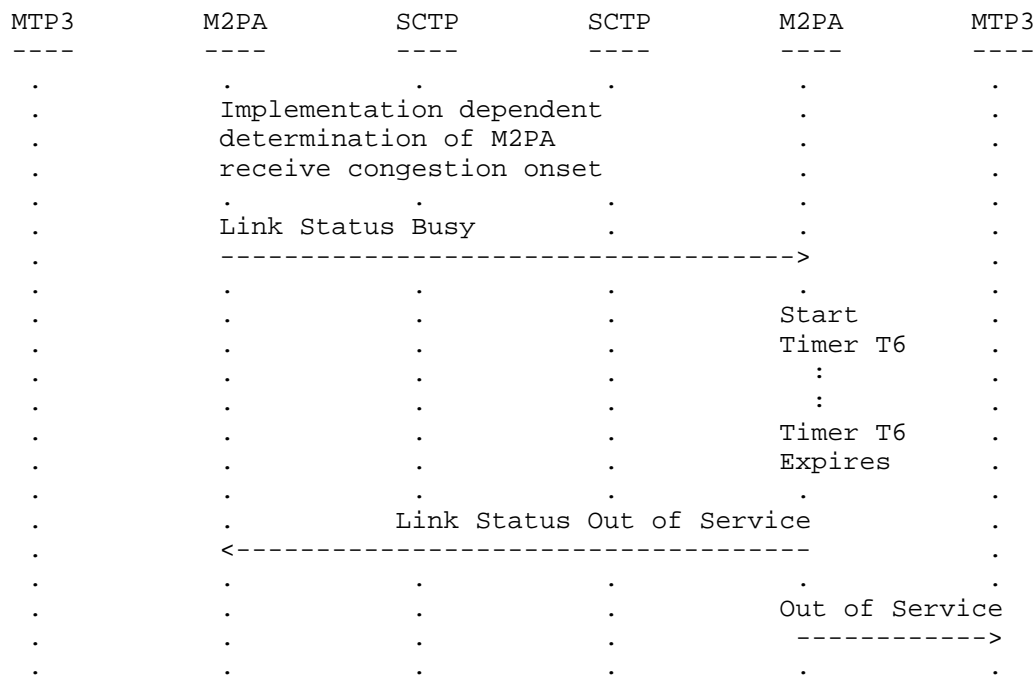

Figure 18. Example: Level 2 Flow Control - Timer T6 Expires

5.6. MTP3 Signaling Link Congestion

In Figure 19, M2PA notifies MTP3 of congestion onset and abatement. The notification includes the congestion level, if there are levels of congestion defined.

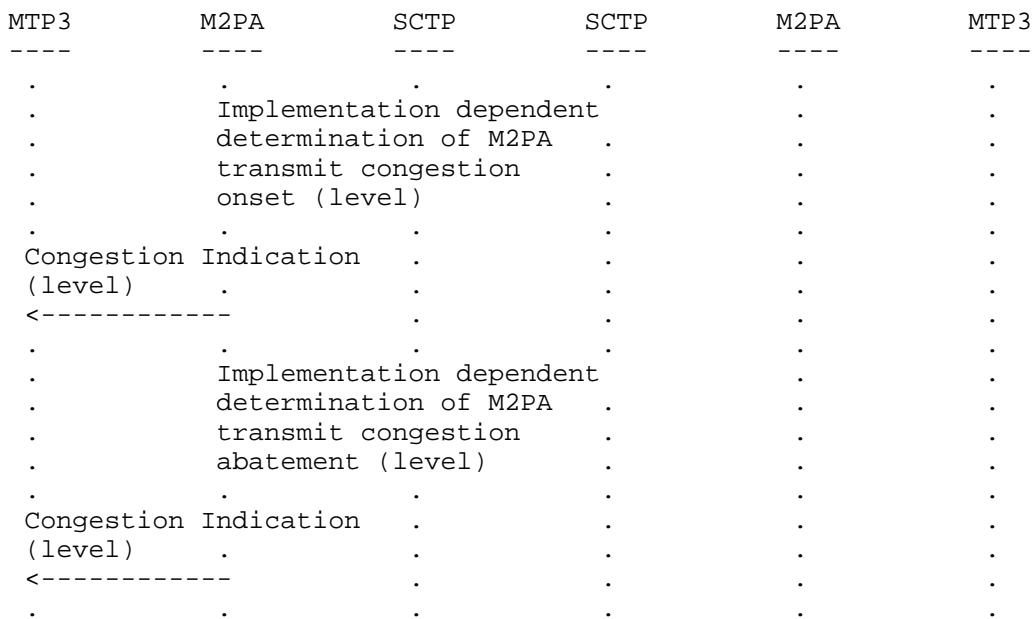

Figure 19. Example: MTP3 Signaling Link Congestion

5.7. Link Deactivation

Figure 20 shows an example of link deactivation. MTP3 can request that a link be taken out of service.

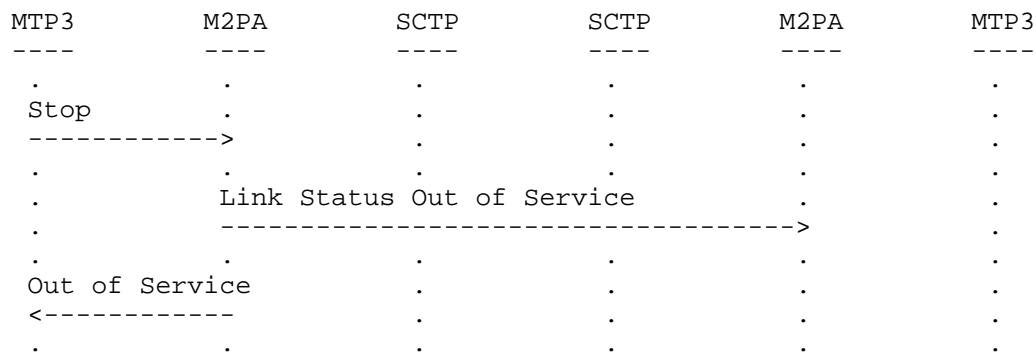

Figure 20. Example: Link Deactivation

5.8. Link Changeover

In Figure 21, MTP3 performs a changeover because the link went out of service. MTP3 selects a different link to retransmit the unacknowledged and unsent messages.

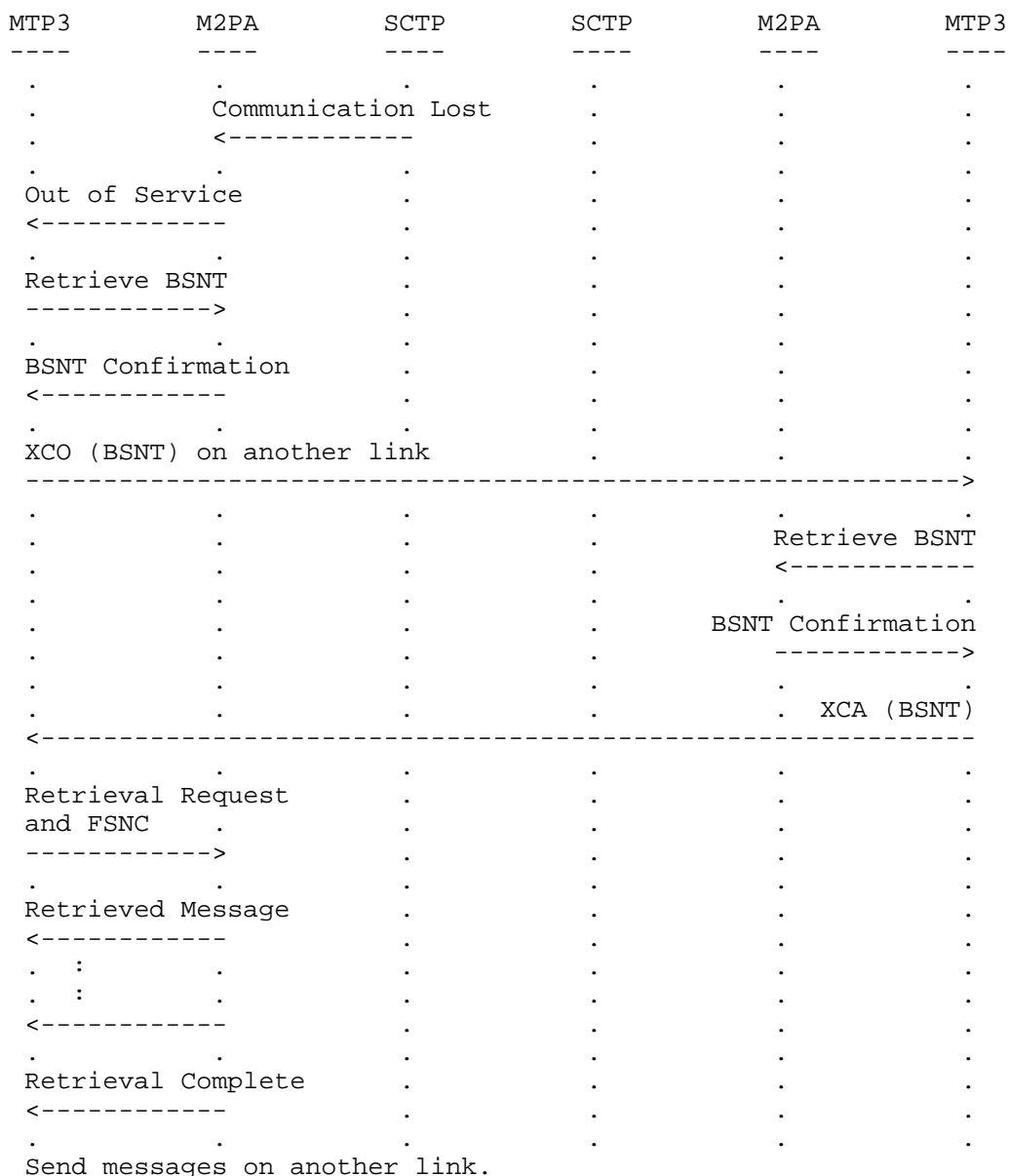

Figure 21. Example: Link Changeover

6. Security Considerations

M2PA is designed to carry signaling messages for telephony services. As such, M2PA MUST involve the security needs of several parties:

- the end users of the services
- the network providers
- the applications involved

Additional requirements MAY come from local regulation.

While these parties may have some overlapping security needs, their needs may not be identical. Any security solution SHOULD fulfill all of the different parties' needs.

Consult [RFC3788] for a discussion of security requirements and for guidance on the use of security protocols. Implementers of M2PA MUST follow the guidelines in [RFC3788].

7. IANA Considerations

7.1. SCTP Payload Protocol Identifier

The SCTP Registered User Port Number Assignment for M2PA is 3565. The TCP Registered User Port Number 3565 is also assigned to M2PA, in case a specification for M2PA over TCP is created.

The value assigned by IANA for the Payload Protocol Identifier in the SCTP Payload Data chunk is

M2PA	5
------	---

The SCTP Payload Protocol Identifier is included in each SCTP Data chunk, to indicate which protocol the SCTP is carrying. This Payload Protocol Identifier is not directly used by SCTP but may be used by certain network entities to identify the type of information being carried in a Data chunk.

The User Adaptation peer may use the Payload Protocol Identifier as a way of determining additional information about the data being presented to it by SCTP.

7.2. M2PA Protocol Extensions

This protocol may be extended through IANA in three ways:

- through definition of additional message classes,
- through definition of additional message types, and
- through definition of additional message parameters.

The definition and use of new message classes, types, and parameters is an integral part of SIGTRAN adaptation layers. Thus, these extensions are assigned by IANA through an IETF Consensus action as defined in [RFC2434].

The proposed extension must in no way adversely affect the general working of the protocol.

The defined values for the message classes, types, and parameters are listed in the Signaling User Adaptation Layer registry (sigtran-adapt).

7.2.1. IETF Defined Message Classes

The documentation for a new message class MUST include the following information:

- (a) A long and short name for the message class.
- (b) A detailed description of the purpose of the message class.

7.2.2 IETF Defined Message Types

Documentation of the message type MUST contain the following information:

- (a) A long and short name for the new message type.
- (b) A detailed description of the structure of the message.
- (c) A detailed definition and description of the intended use of each field within the message.
- (d) A detailed procedural description of the use of the new message type within the operation of the protocol.
- (e) A detailed description of error conditions when receiving this message type.

When an implementation receives a message type that it does not support, it MUST discard the message.

7.2.3. IETF-defined Parameter Extension

Documentation of the message parameter MUST contain the following information:

- (a) Name of the parameter type.
- (b) Detailed description of the structure of the parameter field.
- (c) Detailed definition of each component of the parameter value.
- (d) Detailed description of the intended use of this parameter type, and an indication of whether, and under what circumstances, multiple instances of this parameter type may be found within the same message type.

7.2.4. Defined Values

This section lists the values defined in this document that should be included in the Signaling User Adaptation Layer registry (sigtran-adapt).

The following values for Message Class are defined in this document:

Value (decimal)	Message Class
-----	-----
11	M2PA Messages

The following values for Message Type are defined in this document:

Value (decimal)	Message Type
-----	-----
1	User Data
2	Link Status

8. Acknowledgements

The authors would like to thank the following for their valuable comments and suggestions: Brian Tatum, Wayne Davis, Cliff Thomas, Jeff Copley, Monique Bernard, Malleswar Kalla, Ian Rytina, Greg Sidebottom, Al Varney, Jeff Craig, and Andrew Booth.

9. References

9.1. Normative References

- [JT-Q703] TTC, "Message Transfer Part Signalling Link," TTC Standard JT-Q703, Telecommunication Technology Committee (TTC), version 3 (April 27, 1994).
- [JT-Q704] TTC, "Message Transfer Part Signalling Network Functions," TTC Standard JT-Q704, Telecommunication Technology Committee (TTC), version 4 (May 30, 2002).
- [Q.703] ITU, "Signalling System No. 7 - Signalling Link," ITU-T Recommendation Q.703, ITU-T Telecommunication Standardization Sector of ITU (July 1996).
- [Q.704] ITU, "Message Transfer Part - Signalling Network Functions and Messages," ITU-T Recommendation Q.704, ITU-T Telecommunication Standardization Sector of ITU (July 1996).
- [Q.2140] ITU, "B-ISDN ATM Adaptation Layer - Service Specific Coordination Function for Signalling at the Network Node Interface (SSCF at NNI)," ITU-T Recommendation Q.2140, ITU-T Telecommunication Standardization Sector of ITU (February 1995).
- [Q.2210] ITU, "Message Transfer Part Level 3 Functions and Messages Using the Services of ITU-T Recommendation Q.2140," ITU-T Recommendation Q.2210, ITU-T Telecommunication Standardization Sector of ITU (July 1996).
- [RFC791] Postel, J., "Internet Protocol", STD 5, RFC 791, September 1981.
- [RFC2119] Bradner, S., "Key words for use in RFCs to Indicate Requirement Levels", BCP 14, RFC 2119, March 1997.
- [RFC2434] Narten, T. and H. Alvestrand, "Guidelines for Writing an IANA Considerations Section in RFCs", BCP 26, RFC 2434, October 1998.
- [RFC2960] Stewart, R., Xie, Q., Morneault, K., Sharp, C., Schwarzbauer, H., Taylor, T., Rytina, I., Kalla, M., Zhang, L., and V. Paxson, "Stream Control Transmission Protocol", RFC 2960, October 2000.

- [RFC3309] Stone, J., Stewart, R., and D. Otis, "Stream Control Transmission Protocol (SCTP) Checksum Change", RFC 3309, September 2002.
- [RFC3788] Loughney, J., Tuexen, M., and J. Pastor-Balbas, "Security Considerations for Signaling Transport (SIGTRAN) Protocols", RFC 3788, June 2004.
- [T1.111] ANSI, "American National Standard for Telecommunications - Signaling System Number 7 (SS7) - Message Transfer Part (MTP)," ANSI T1.111-2001, American National Standards Institute (February 2001).

9.2. Informative References

- [M2UA] K. Morneault, et. al., "Signaling System 7 (SS7) Message Transfer Part 2 (MTP2) - User Adaptation Layer," RFC 3331, Internet Engineering Task Force - Signalling Transport Working Group (September, 2002).
- [Q.700] ITU, "Introduction to CCITT Signalling System No. 7," ITU-T Recommendation Q.700, ITU-T Telecommunication Standardization Sector of ITU (March 1993).
- [Q.701] ITU, "Functional Description of the Message Transfer Part (MTP) of Signalling System No. 7," ITU-T Recommendation Q.701, ITU-T Telecommunication Standardization Sector of ITU (March 1993).
- [Q.702] ITU, "Signalling Data Link," ITU-T Recommendation Q.702, ITU-T Telecommunication Standardization Sector of ITU (November 1988).
- [Q.705] ITU, "Signalling System No. 7 - Signalling Network Structure," ITU-T Recommendation Q.705, ITU-T Telecommunication Standardization Sector of ITU (March 1993).
- [RFC2719] Ong, L., Rytina, I., Garcia, M., Schwarzbauer, H., Coene, L., Lin, H., Juhasz, I., Holdrege, M., and C. Sharp, "Framework Architecture for Signaling Transport", RFC 2719, October 1999.

Authors' Addresses

Tom George
Plano, TX
USA

Phone: +1-972-985-4594
EMail: tgeorge_tx@verizon.net

Brian Bidulock
OpenSS7 Corporation
1469 Jeffreys Crescent
Edmonton, AB T6L 6T1
Canada

Phone: +1-780-490-1141
EMail: bidulock@openss7.org

Ram Dantu, Ph.D.
Assistant Professor
Department of Computer Science
University of North Texas
Denton, TX 76203
USA

Phone: +1-940-565-2822
EMail: rdantu@unt.edu

Hanns Juergen Schwarzbauer
SIEMENS AG
Hofmannstr. 51
81359 Munich
Germany

Phone: +49-89-722-24236
EMail: HannsJuergen.Schwarzbauer@Siemens.com

Ken Morneault
Cisco Systems Inc.
13615 Dulles Technology Drive
Herndon, VA 20171
USA

Phone: +1-703-484-3323
EMail: kmorneau@cisco.com

Full Copyright Statement

Copyright (C) The Internet Society (2005).

This document is subject to the rights, licenses and restrictions contained in BCP 78, and except as set forth therein, the authors retain all their rights.

This document and the information contained herein are provided on an "AS IS" basis and THE CONTRIBUTOR, THE ORGANIZATION HE/SHE REPRESENTS OR IS SPONSORED BY (IF ANY), THE INTERNET SOCIETY AND THE INTERNET ENGINEERING TASK FORCE DISCLAIM ALL WARRANTIES, EXPRESS OR IMPLIED, INCLUDING BUT NOT LIMITED TO ANY WARRANTY THAT THE USE OF THE INFORMATION HEREIN WILL NOT INFRINGE ANY RIGHTS OR ANY IMPLIED WARRANTIES OF MERCHANTABILITY OR FITNESS FOR A PARTICULAR PURPOSE.

Intellectual Property

The IETF takes no position regarding the validity or scope of any Intellectual Property Rights or other rights that might be claimed to pertain to the implementation or use of the technology described in this document or the extent to which any license under such rights might or might not be available; nor does it represent that it has made any independent effort to identify any such rights. Information on the procedures with respect to rights in RFC documents can be found in BCP 78 and BCP 79.

Copies of IPR disclosures made to the IETF Secretariat and any assurances of licenses to be made available, or the result of an attempt made to obtain a general license or permission for the use of such proprietary rights by implementers or users of this specification can be obtained from the IETF on-line IPR repository at <http://www.ietf.org/ipr>.

The IETF invites any interested party to bring to its attention any copyrights, patents or patent applications, or other proprietary rights that may cover technology that may be required to implement this standard. Please address the information to the IETF at ietf-ipr@ietf.org.

Acknowledgement

Funding for the RFC Editor function is currently provided by the Internet Society.